

The TSA heavy duty extruded aluminium curtain track is suitable for use in schools, theatres, and many other commercial applications. The track is designed to cater for large and/or heavy drapes.

It can be fitted directly to overhead soffit fixings, or secured by a variety of available track hanging brackets.

Features

- Anodised black matt finish
- Wide variety of accessories
- Easily curved
- No welding required
- Light weight (1.62 kg/m)
- Can be fixed at 2.0–2.5 m centres

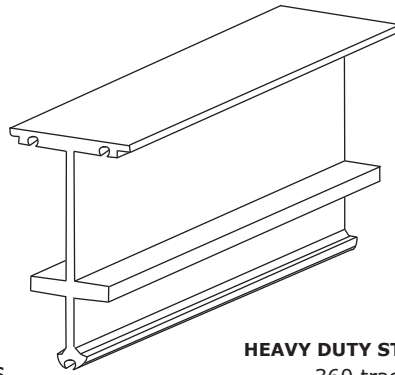

HEAVY DUTY STAGE TRACK
360 track hd

TECHNICAL DATA

Weight : 1.578 kg/m
Material : Aluminium
Finish : Black anodised
Standard length: 6 mts

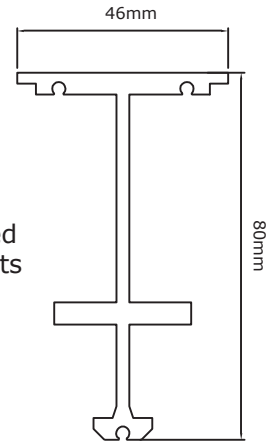

TRACK SECTION

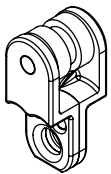

RUNNER
362 runner

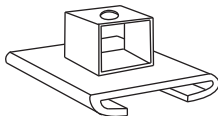

HANGING BRACKET BLOCK
363 hbracket block

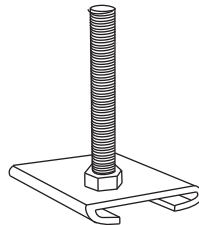

HANGING BRACKET M10
363 hbracket thr

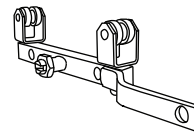

MASTER CARRIER-cranked
365 crledr

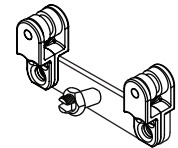

MASTER CARRIER-straight
365 stledr

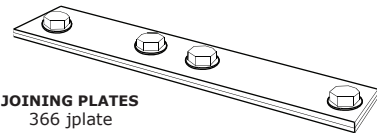

JOINING PLATES
366 jplate
(Includes 3 joining pins)

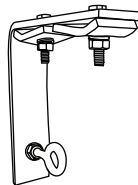

ROPE GUIDE
364 pickup lb

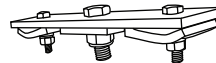

TRACK SPACER CLAMP
368 trk cl



WEIGHTED FLOOR PULLEY
367 w8t puly

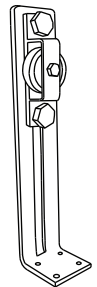

**ADJUSTABLE PULLEY
FLOOR MOUNTED**
367 ajs puly



LIVE PULLEY
367 lv puly



DEAD PULLEY
367 dd puly

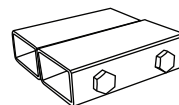

SINGLE PULLEY PACKER
368 trk pkr

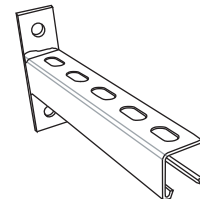

WALL BRACKET - 250mm
304 WB 250

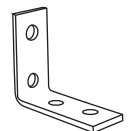

L-BRACKET
100mm x 110mm
304 LB 100



90 DEGREE TRACK BEND
800mm RADIUS
360 hd 8b

90 DEGREE TRACK BEND
600mm RADIUS
360 hd 6b

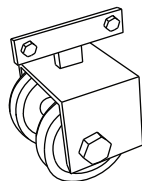

END PULLEY-DOUBLE
367 dbl puly

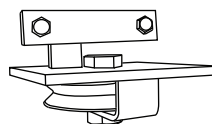

END PULLEY-SINGLE
367 sgl puly