

The light duty extruded aluminium curtain track is suitable for use in schools, theatres, and many other commercial applications. The track is designed to cater for small or light drapes, and is ideal for windows. It can be fitted directly to overhead soffit fixings, or face fixed via a wall bracket.

Features

- Wide variety of accessories
- Easily curved
- No welding required
- Light weight

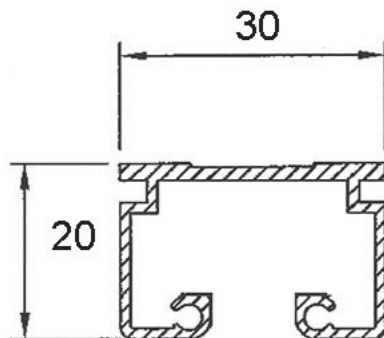

TRACK SECTION

TECHNICAL DATA

Weight : 0.36 kg/m
Material : Aluminium
Finish : Silver anodised
Standard length : 6 metres

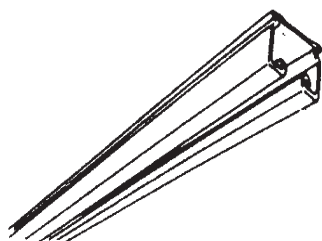

LIGHT DUTY STAGE TRACK
360 track Id



RUNNER
362 runner Id

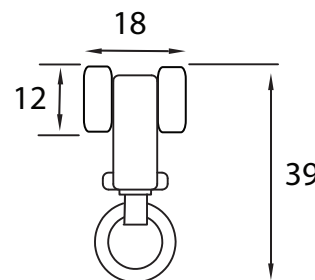

RUNNER SPECIFICATIONS

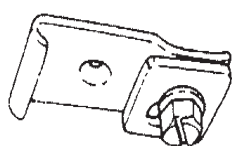

CEILING BRACKET
363 cbracket

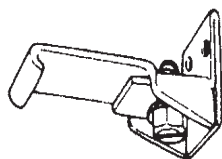

WALL BRACKET
363 wbracket

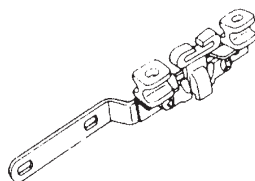

MASTER CARRIER-cranked
365 crledr Id

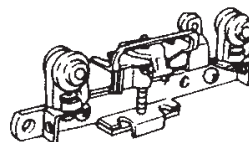

MASTER CARRIER-straight
365 stledr Id



END CAP
368 end cap



90 DEGREE TRACK BEND
450mm RADIUS
360 Id 450b



TRACK JOINING PINS
368 join pins Id

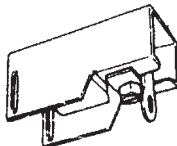

END PULLEY-SINGLE
367 sgl puly Id

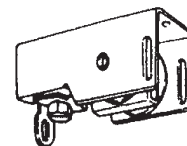

END PULLEY-DOUBLE
367 dbl puly Id

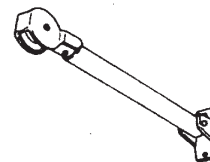

**ADJUSTABLE PULLEY
FLOOR MOUNTED**
367 ajs puly Id